



Handmade  
*in the heart of*  
BRITAIN

**4-350-29-xx**

Brass Rail Single Towel Bar

14 July 2021

44H x 738W x 77D

- |                             |                         |
|-----------------------------|-------------------------|
| UB - UNLACQUERED BRASS      | CP - POLISHED CHROME    |
| BB - BRUSHED BRASS          | NP - POLISHED NICKEL    |
| BN - BRUSHED NICKEL         | LB - LIGHT BRONZE       |
| LAB - LIGHT ANTIQUE BRONZE  | MB - MEDIUM BRONZE      |
| MAB - MEDIUM ANTIQUE BRONZE | DB - DARK BRONZE        |
| DAB - DARK ANTIQUE BRONZE   | GP - GOLD PLATED        |
| AG - ANTIQUE GOLD           | GM - GUN METAL          |
| MWP - MATT WHITE P.COAT     | MBP - MATT BLACK P.COAT |

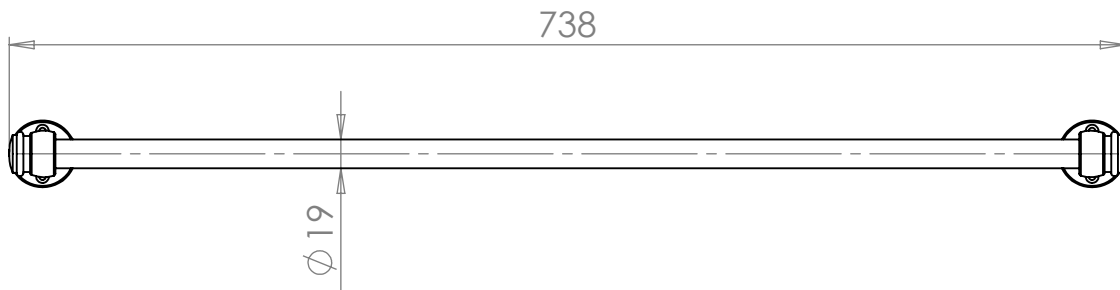
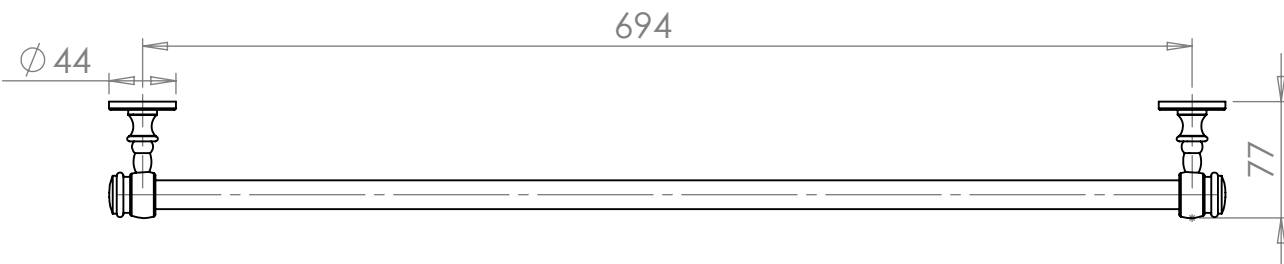
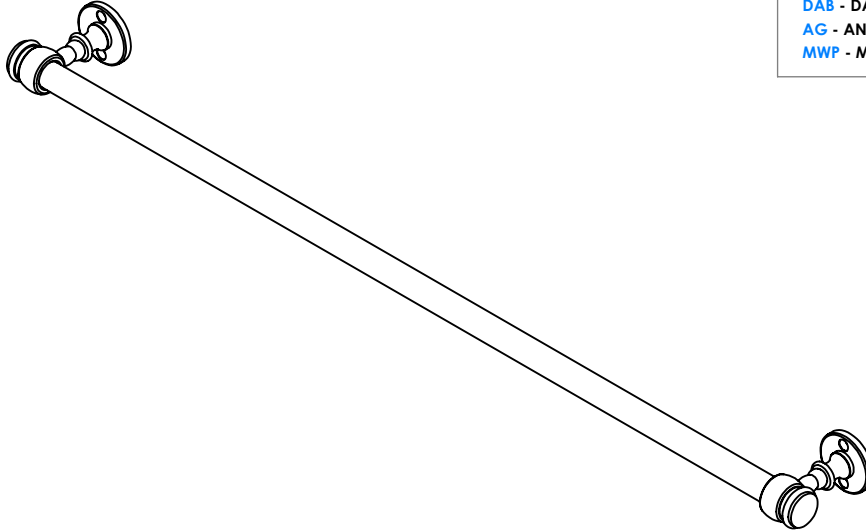

**THE STERLINGHAM** CO. LTD.

SCALE: 1:5 | APPROX WEIGHT 0.85KG

MANUFACTURED FROM BRASS

Units 2 & 2A Stamford Street  
Amblecote, Stourbridge,  
Worcestershire  
England, DY8 4HR

Telephone : 01384 370901  
Fax : 01384 880159  
sales@sterlingham.co.uk  
www.sterlingham.co.uk



Handmade  
in the heart of  
BRITAIN

# 4-350-29CLD-xx

## Brass Rail Single Towel Bar

14 July 2021

41H x 738W x 83D

- |                             |                         |
|-----------------------------|-------------------------|
| UB - UNLACQUERED BRASS      | CP - POLISHED CHROME    |
| BB - BRUSHED BRASS          | NP - POLISHED NICKEL    |
| BN - BRUSHED NICKEL         | LB - LIGHT BRONZE       |
| LAB - LIGHT ANTIQUE BRONZE  | MB - MEDIUM BRONZE      |
| MAB - MEDIUM ANTIQUE BRONZE | DB - DARK BRONZE        |
| DAB - DARK ANTIQUE BRONZE   | GP - GOLD PLATED        |
| AG - ANTIQUE GOLD           | GM - GUN METAL          |
| MWP - MATT WHITE P.COAT     | MBP - MATT BLACK P.COAT |

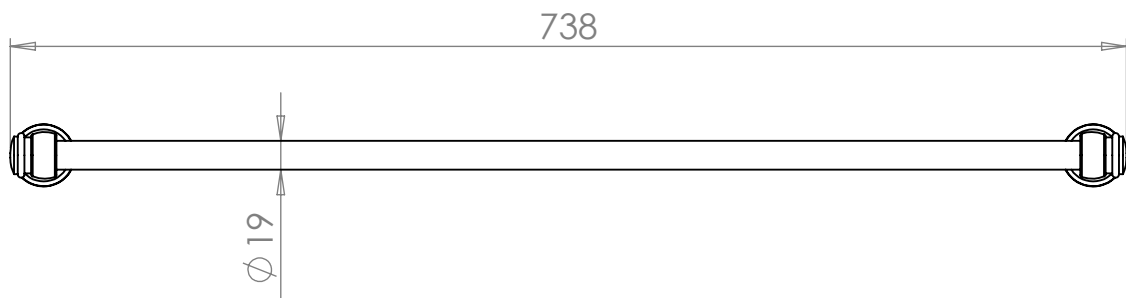
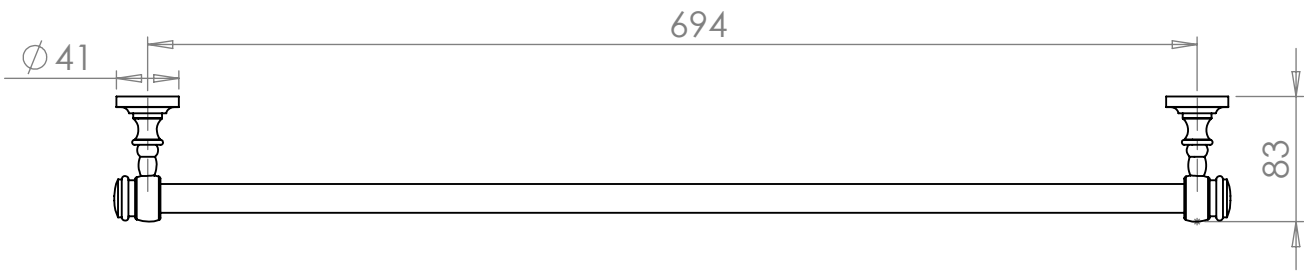
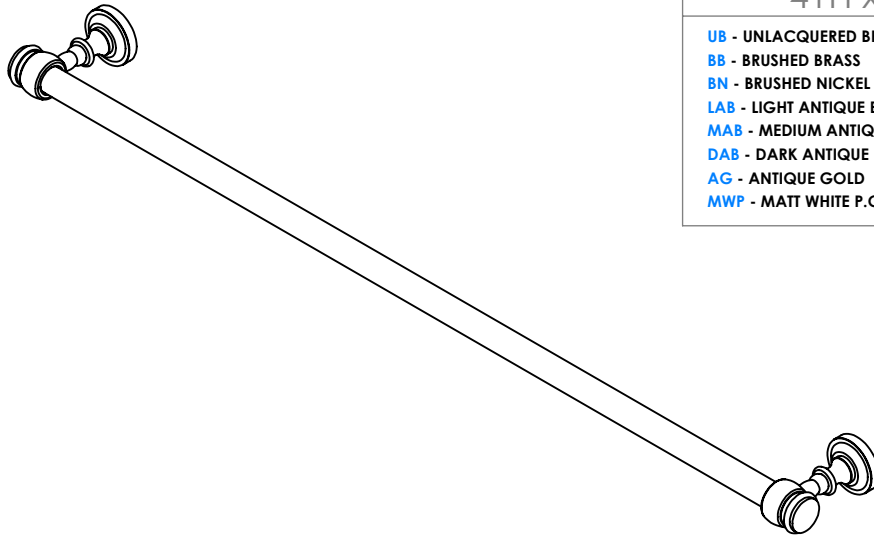

### THE STERLINGHAM CO. LTD.

SCALE: 1:5 | APPROX WEIGHT 0.85KG

MANUFACTURED FROM BRASS

Units 2 & 2A Stamford Street  
Amblecote, Stourbridge,  
Worcestershire  
England, DY8 4HR

Telephone : 01384 370901  
Fax : 01384 880159  
sales@sterlingham.co.uk  
www.sterlingham.co.uk



Handmade  
*in the heart of*  
BRITAIN

4-350-18xx

Brass Rail Single Towel Bar

06 July 2021

44 x 457 x 77

- |                             |                         |
|-----------------------------|-------------------------|
| UB - UNLACQUERED BRASS      | CP - POLISHED CHROME    |
| BB - BRUSHED BRASS          | NP - POLISHED NICKEL    |
| BN - BRUSHED NICKEL         | LB - LIGHT BRONZE       |
| LAB - LIGHT ANTIQUE BRONZE  | MB - MEDIUM BRONZE      |
| MAB - MEDIUM ANTIQUE BRONZE | DB - DARK BRONZE        |
| DAB - DARK ANTIQUE BRONZE   | GP - GOLD PLATED        |
| AG - ANTIQUE GOLD           | GM - GUN METAL          |
| MWP - MATT WHITE P.COAT     | MBP - MATT BLACK P.COAT |

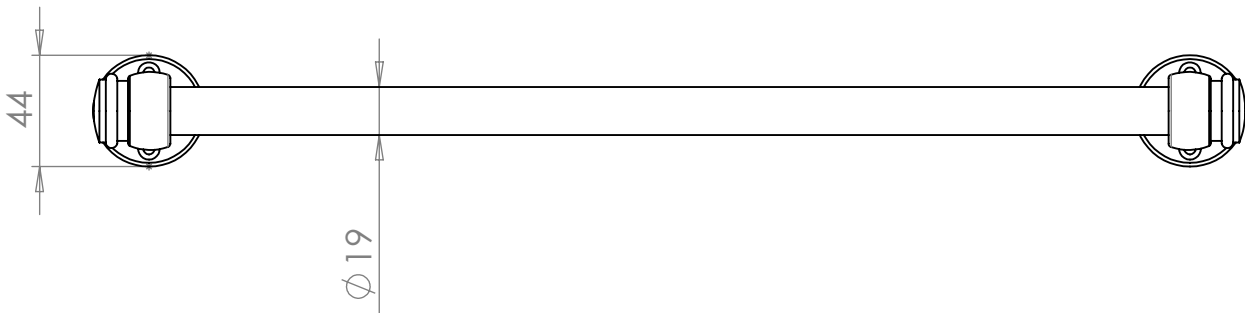
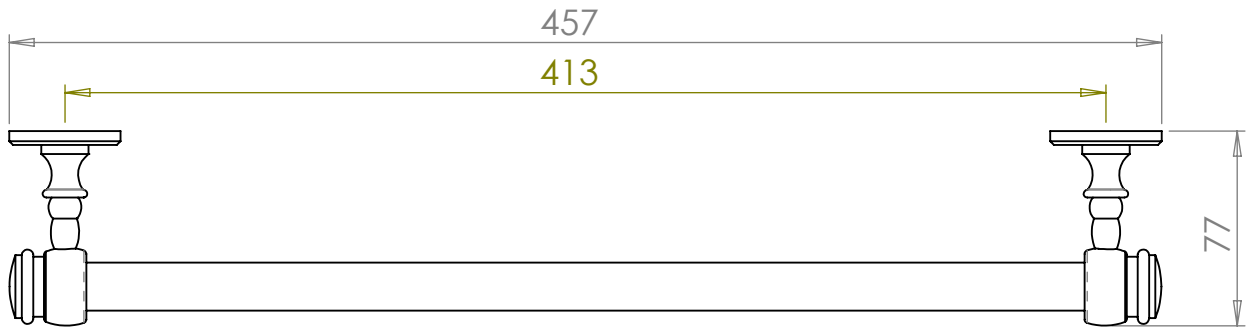
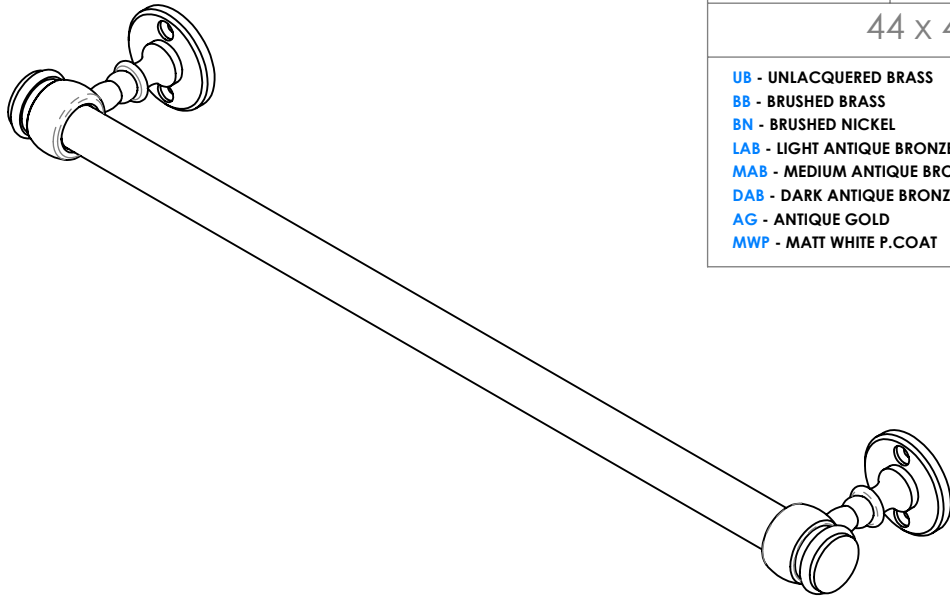

**THE STERLINGHAM** CO. LTD.

SCALE: 1:3

APPROX WEIGHT 0.69KG

MANUFACTURED FROM BRASS

Units 2 & 2A Stamford Street  
Amblecote, Stourbridge,  
Worcestershire  
England, DY8 4HR

Telephone : 01384 370901  
Fax : 01384 880159  
sales@sterlingham.co.uk  
www.sterlingham.co.uk



Handmade  
*in the heart of*  
BRITAIN

# Single Brass Towel Bar

4-350-18CLD-XX

06 July 2021

41H x 457W x 83D

- |                             |                         |
|-----------------------------|-------------------------|
| UB - UNLACQUERED BRASS      | CP - POLISHED CHROME    |
| BB - BRUSHED BRASS          | NP - POLISHED NICKEL    |
| BN - BRUSHED NICKEL         | LB - LIGHT BRONZE       |
| LAB - LIGHT ANTIQUE BRONZE  | MB - MEDIUM BRONZE      |
| MAB - MEDIUM ANTIQUE BRONZE | DB - DARK BRONZE        |
| DAB - DARK ANTIQUE BRONZE   | GP - GOLD PLATED        |
| AG - ANTIQUE GOLD           | GM - GUN METAL          |
| MWP - MATT WHITE P.COAT     | MBP - MATT BLACK P.COAT |

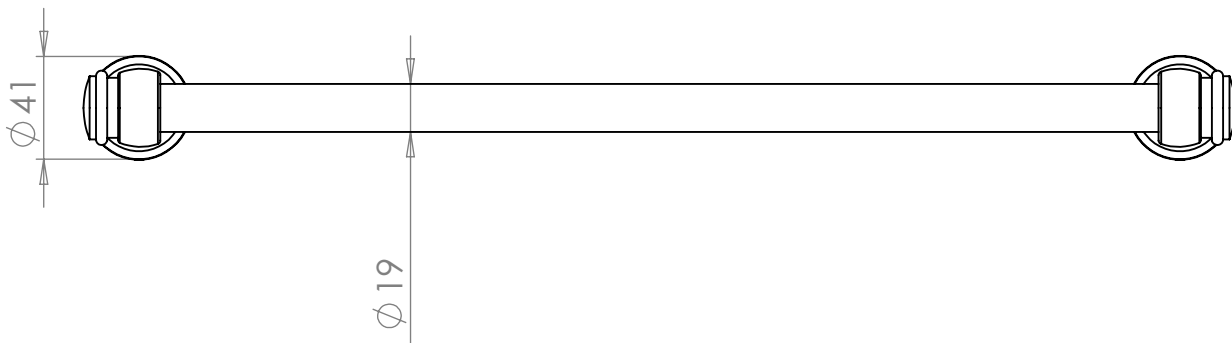
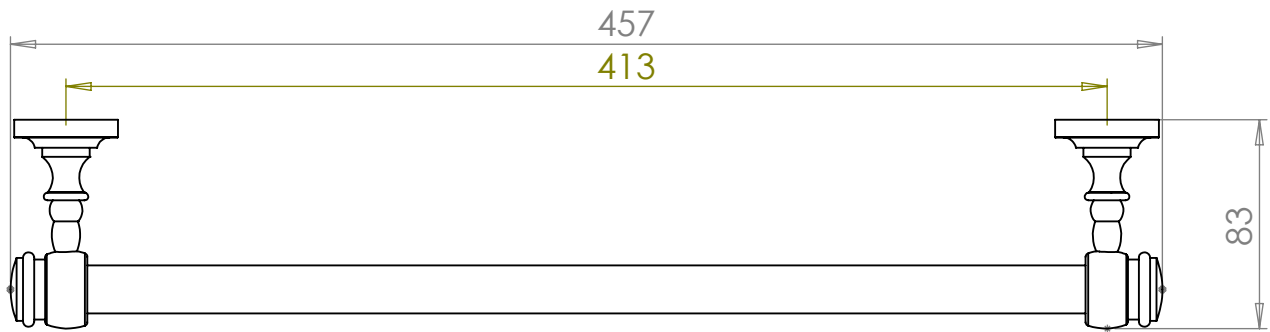
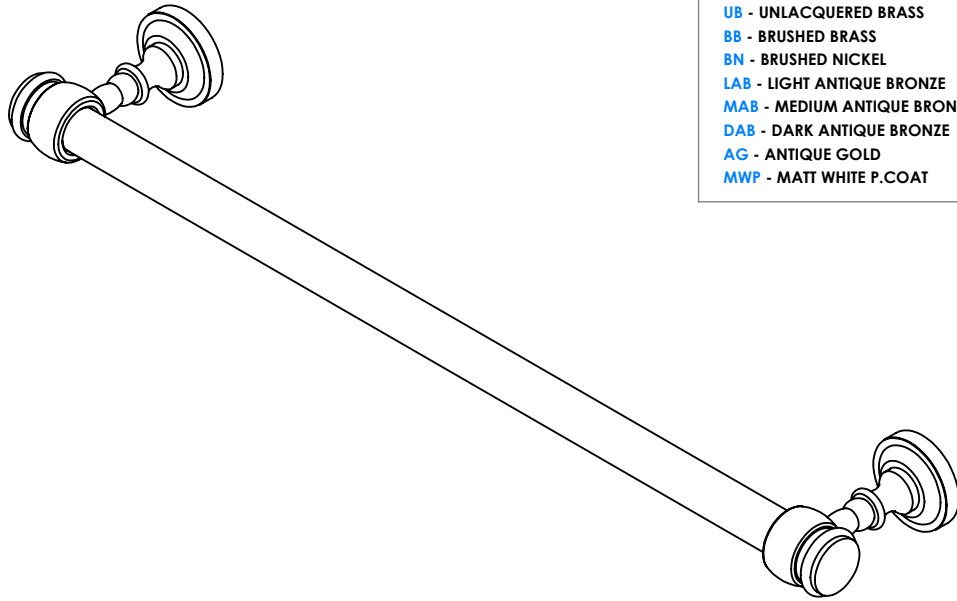

## THE STERLINGHAM CO. LTD

SCALE: 1:2 | APPROX WEIGHT 0.69KG

MANUFACTURED FROM BRASS

Units 2 & 2A Stamford Street  
Amblecote, Stourbridge,  
Worcestershire  
England, DY8 4HR

Telephone : 01384 370901  
Fax : 01384 880159  
sales@sterlingham.co.uk  
www.sterlingham.co.uk



Handmade  
*in the heart of*  
BRITAIN

### 4-350-23xx

Brass Rail Single Towel Bar

10 September 2019

44H x 585W x 77D

- |                             |                         |
|-----------------------------|-------------------------|
| UB - UNLACQUERED BRASS      | CP - POLISHED CHROME    |
| BB - BRUSHED BRASS          | NP - POLISHED NICKEL    |
| BN - BRUSHED NICKEL         | LB - LIGHT BRONZE       |
| LAB - LIGHT ANTIQUE BRONZE  | MB - MEDIUM BRONZE      |
| MAB - MEDIUM ANTIQUE BRONZE | DB - DARK BRONZE        |
| DAB - DARK ANTIQUE BRONZE   | GP - GOLD PLATED        |
| AG - ANTIQUE GOLD           | GM - GUN METAL          |
| MWP - MATT WHITE P.COAT     | MBP - MATT BLACK P.COAT |

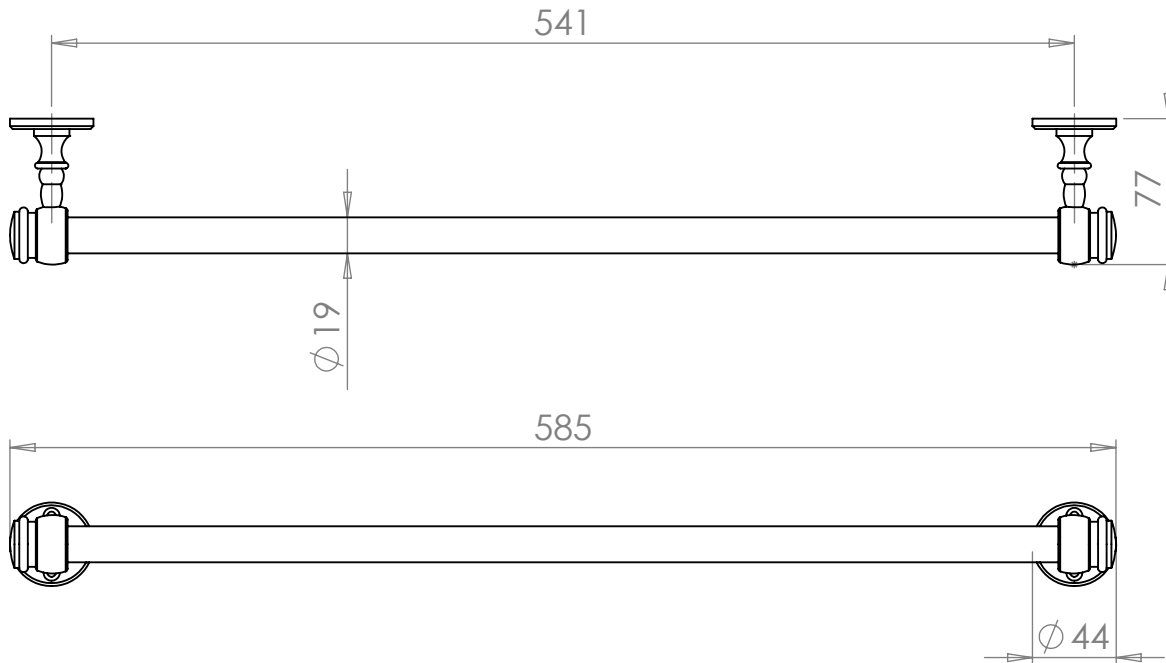
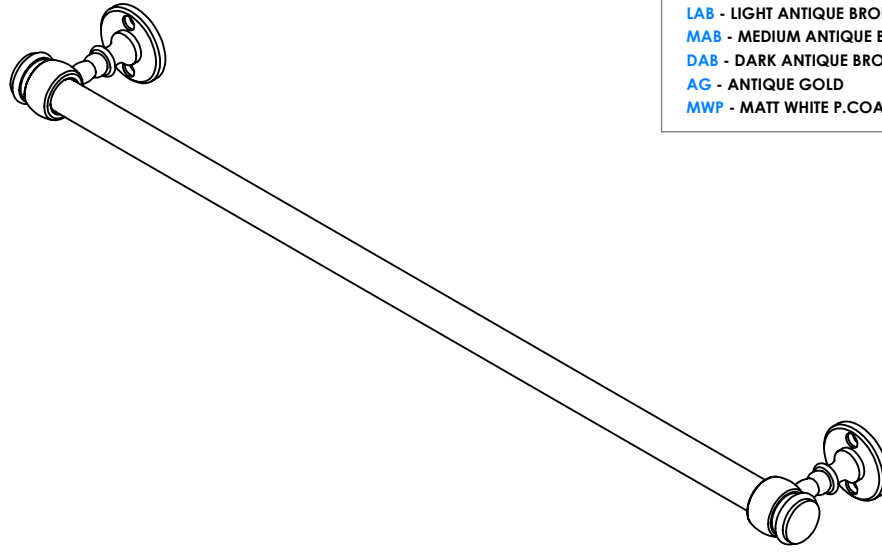

## THE STERLINGHAM CO. LTD

SCALE: 1:4 | APPROX WEIGHT 0.75KG

MANUFACTURED FROM BRASS

Units 2 & 2A Stamford Street  
Amblecote, Stourbridge,  
Worcestershire  
England, DY8 4HR

Telephone : 01384 370901  
Fax : 01384 880159  
sales@sterlingham.co.uk  
www.sterlingham.co.uk



Handmade  
*in the heart of*  
BRITAIN

**4-350-23xx**

Brass Rail Single Towel Bar

10 September 2019

41H x 585W x 83D

- |                             |                         |
|-----------------------------|-------------------------|
| UB - UNLACQUERED BRASS      | CP - POLISHED CHROME    |
| BB - BRUSHED BRASS          | NP - POLISHED NICKEL    |
| BN - BRUSHED NICKEL         | LB - LIGHT BRONZE       |
| LAB - LIGHT ANTIQUE BRONZE  | MB - MEDIUM BRONZE      |
| MAB - MEDIUM ANTIQUE BRONZE | DB - DARK BRONZE        |
| DAB - DARK ANTIQUE BRONZE   | GP - GOLD PLATED        |
| AG - ANTIQUE GOLD           | GM - GUN METAL          |
| MWP - MATT WHITE P.COAT     | MBP - MATT BLACK P.COAT |

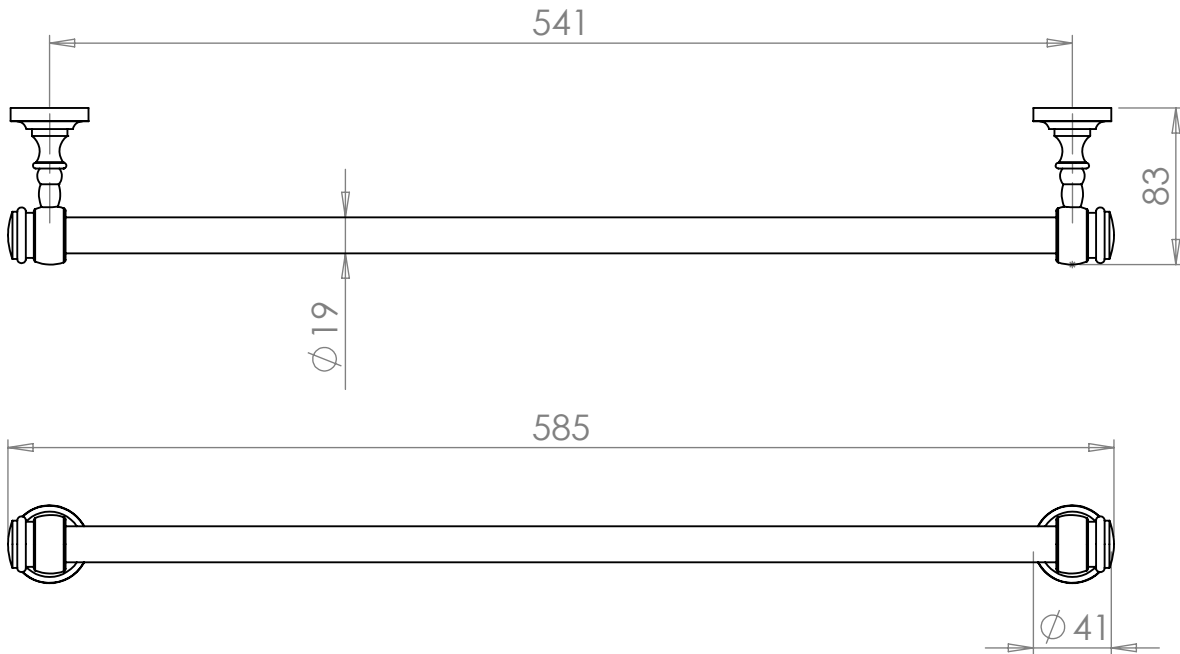
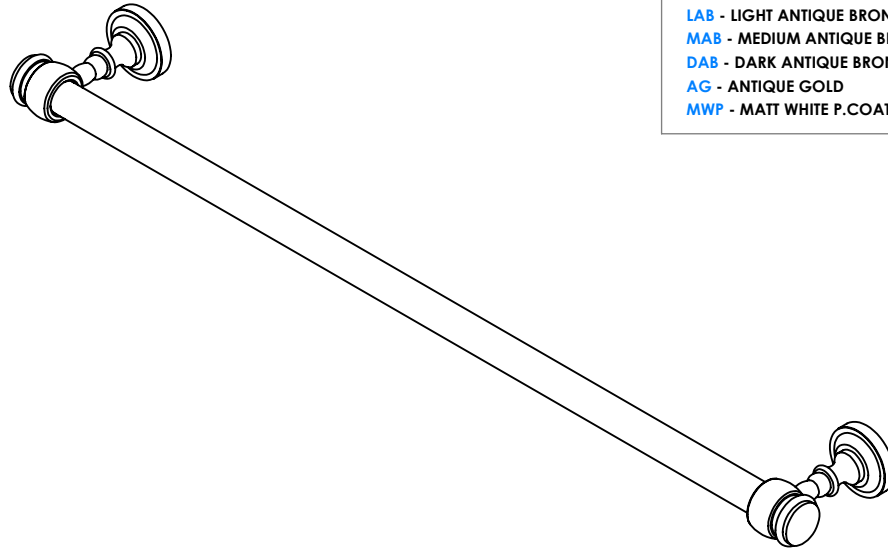

**THE STERLINGHAM** CO. LTD.

SCALE: 1:4 | APPROX WEIGHT 0.75KG

MANUFACTURED FROM BRASS

Units 2 & 2A Stamford Street  
Amblecote, Stourbridge,  
Worcestershire  
England, DY8 4HR

Telephone : 01384 370901  
Fax : 01384 880159  
sales@sterlingham.co.uk  
www.sterlingham.co.uk



Handmade  
in the heart of  
BRITAIN

# 4-350-xx-B

## Brass Rail Single Towel Bar

10 September 2019

41H x 610W x 83D

- |                             |                         |
|-----------------------------|-------------------------|
| UB - UNLACQUERED BRASS      | CP - POLISHED CHROME    |
| BB - BRUSHED BRASS          | NP - POLISHED NICKEL    |
| BN - BRUSHED NICKEL         | LB - LIGHT BRONZE       |
| LAB - LIGHT ANTIQUE BRONZE  | MB - MEDIUM BRONZE      |
| MAB - MEDIUM ANTIQUE BRONZE | DB - DARK BRONZE        |
| DAB - DARK ANTIQUE BRONZE   | GP - GOLD PLATED        |
| AG - ANTIQUE GOLD           | GM - GUN METAL          |
| MWP - MATT WHITE P.COAT     | MBP - MATT BLACK P.COAT |

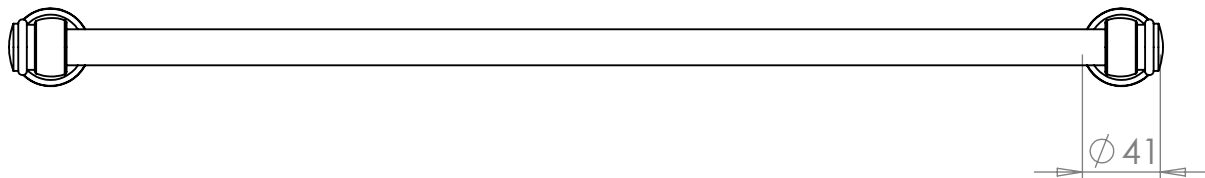
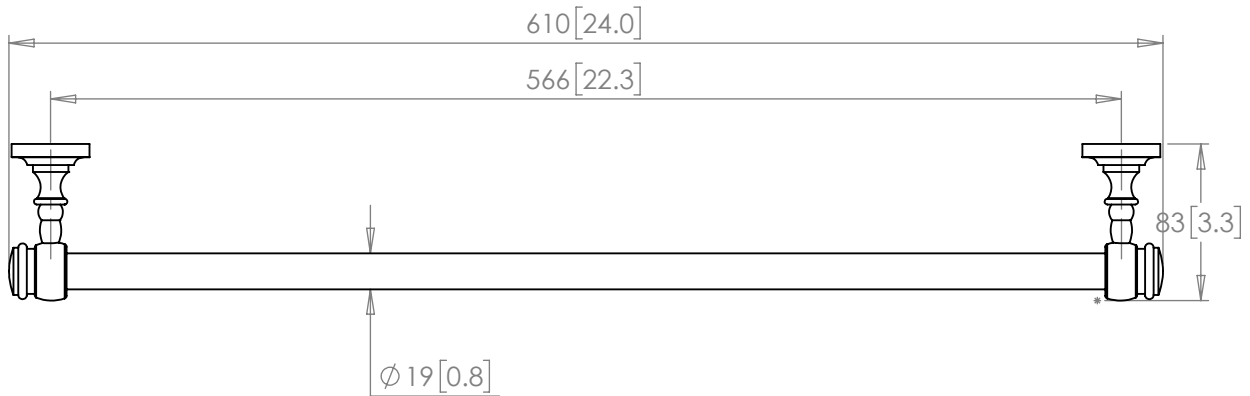
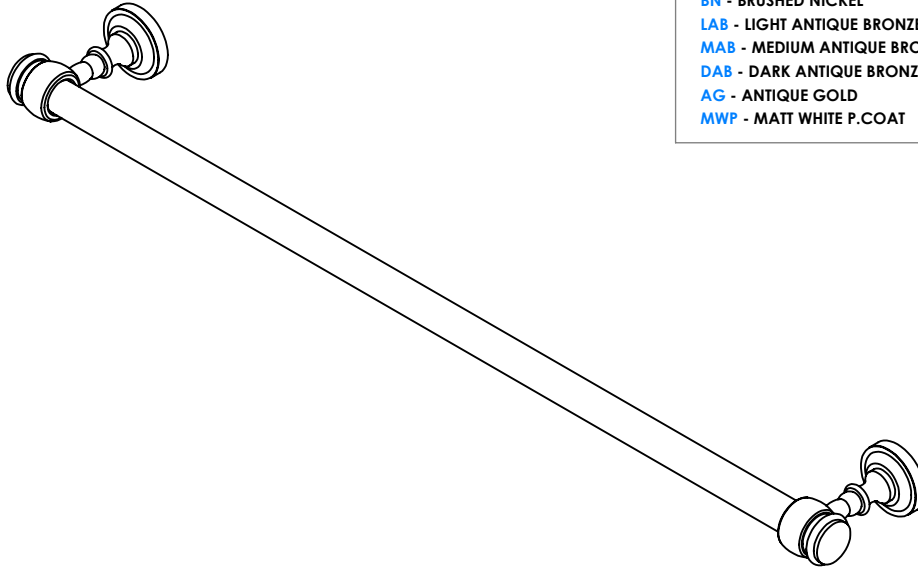

### THE STERLINGHAM CO. LTD.

SCALE: 1:4 | APPROX WEIGHT 0.77KG

MANUFACTURED FROM BRASS

Units 2 & 2A Stamford Street  
Amblecote, Stourbridge,  
Worcestershire  
England, DY8 4HR

Telephone : 01384 370901  
Fax : 01384 880159  
sales@sterlingham.co.uk  
www.sterlingham.co.uk



Handmade  
in the heart of  
BRITAIN

# 4-355-18xx

## Glass Rail Single Towel Bar

06 July 2021

44H x 458W x 77D

- |                             |                         |
|-----------------------------|-------------------------|
| UB - UNLACQUERED BRASS      | CP - POLISHED CHROME    |
| BB - BRUSHED BRASS          | NP - POLISHED NICKEL    |
| BN - BRUSHED NICKEL         | LB - LIGHT BRONZE       |
| LAB - LIGHT ANTIQUE BRONZE  | MB - MEDIUM BRONZE      |
| MAB - MEDIUM ANTIQUE BRONZE | DB - DARK BRONZE        |
| DAB - DARK ANTIQUE BRONZE   | GP - GOLD PLATED        |
| AG - ANTIQUE GOLD           | GM - GUN METAL          |
| MWP - MATT WHITE P.COAT     | MBP - MATT BLACK P.COAT |

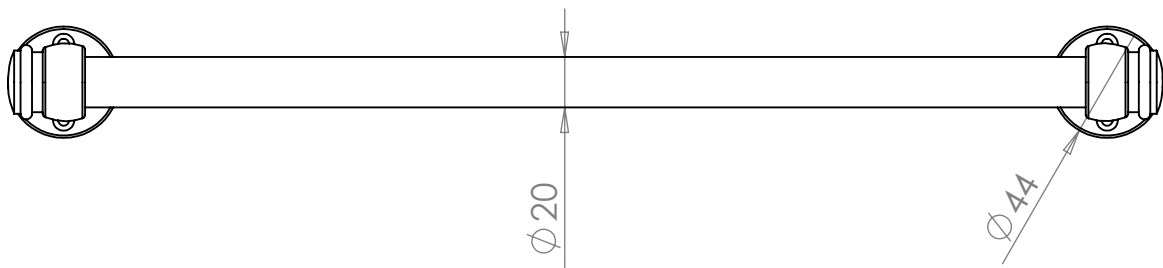
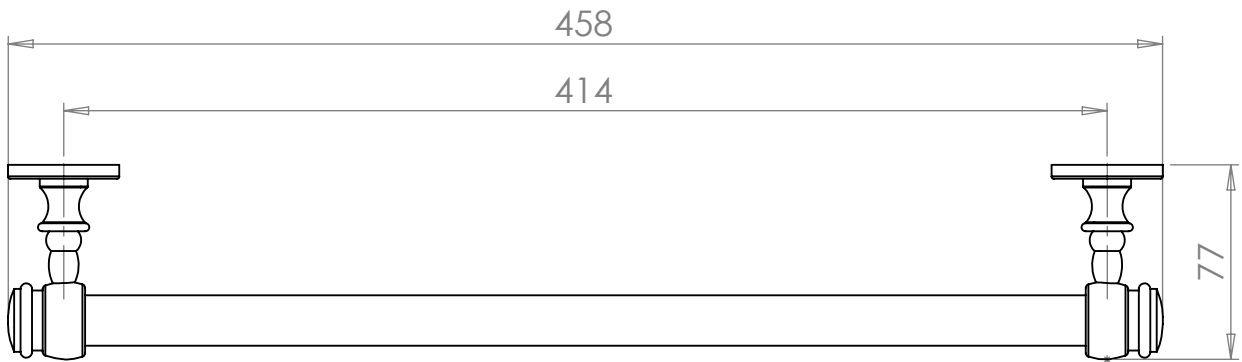
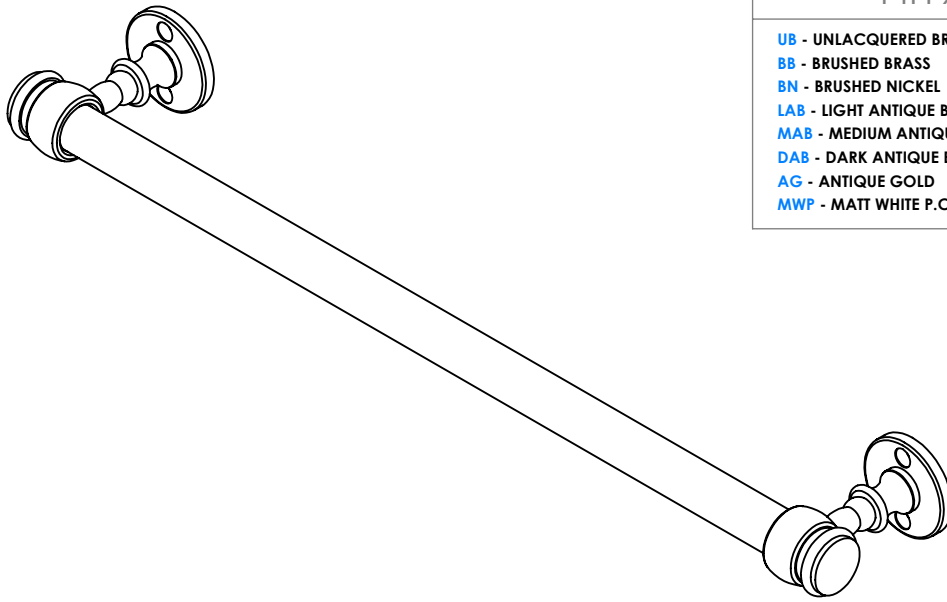

### THE STERLINGHAM CO. LTD.

SCALE: 1:3 | APPROX WEIGHT 0.77KG

MANUFACTURED FROM BRASS

Units 2 & 2A Stamford Street  
Amblecote, Stourbridge,  
Worcestershire  
England, DY8 4HR

Telephone : 01384 370901  
Fax : 01384 880159  
sales@sterlingham.co.uk  
www.sterlingham.co.uk





Handmade  
in the heart of  
BRITAIN

# 4-355-18CLD-xx

## Glass Rail Single Towel Bar

06 July 2021

41H x 458W x 83D

- |                             |                         |
|-----------------------------|-------------------------|
| UB - UNLACQUERED BRASS      | CP - POLISHED CHROME    |
| BB - BRUSHED BRASS          | NP - POLISHED NICKEL    |
| BN - BRUSHED NICKEL         | LB - LIGHT BRONZE       |
| LAB - LIGHT ANTIQUE BRONZE  | MB - MEDIUM BRONZE      |
| MAB - MEDIUM ANTIQUE BRONZE | DB - DARK BRONZE        |
| DAB - DARK ANTIQUE BRONZE   | GP - GOLD PLATED        |
| AG - ANTIQUE GOLD           | GM - GUN METAL          |
| MWP - MATT WHITE P.COAT     | MBP - MATT BLACK P.COAT |

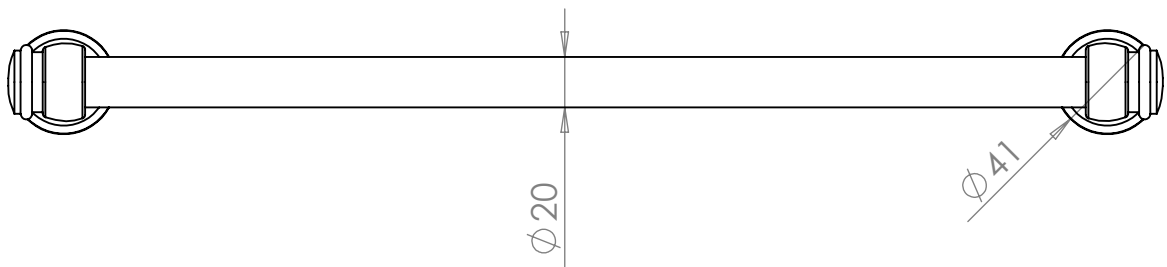
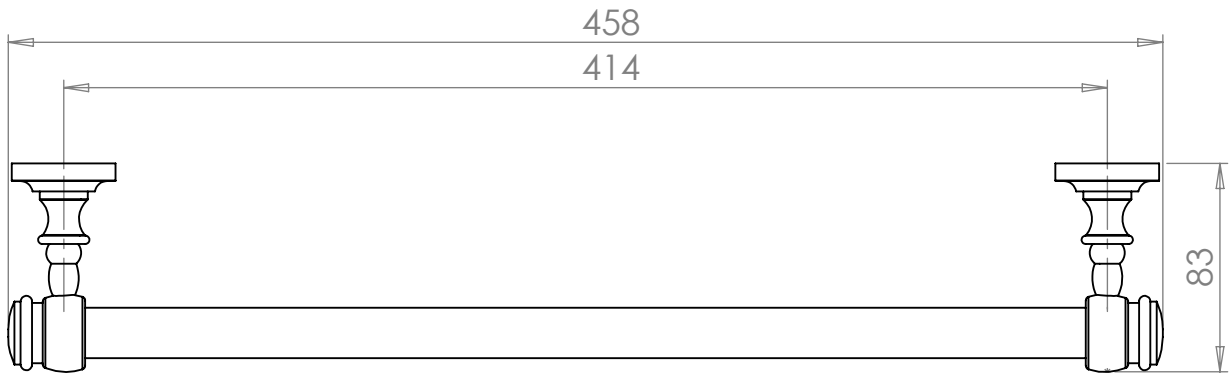
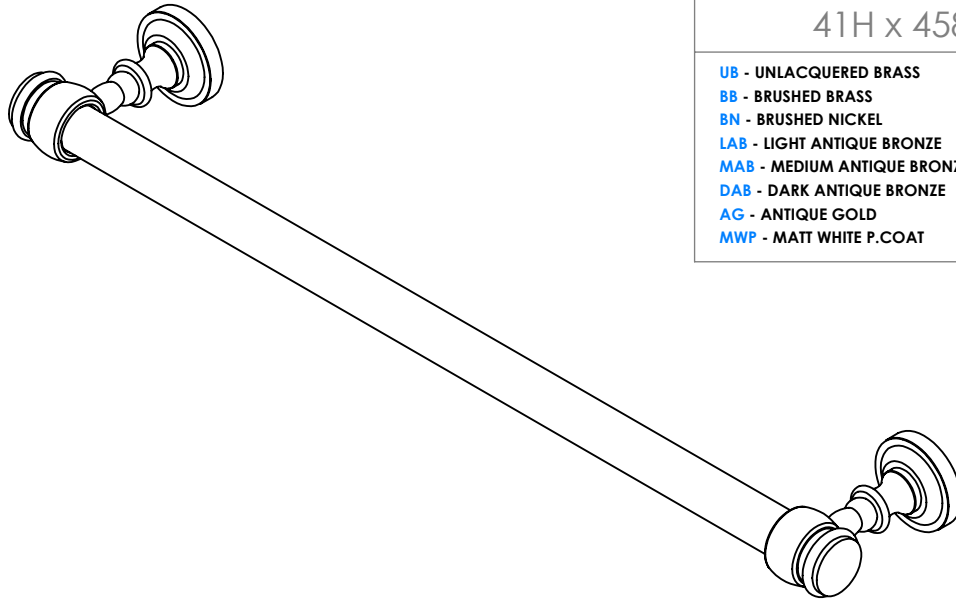

### THE STERLINGHAM CO. LTD.

SCALE: 1:3 | APPROX WEIGHT 0.77KG

MANUFACTURED FROM BRASS

Units 2 & 2A Stamford Street  
Amblecote, Stourbridge,  
Worcestershire  
England, DY8 4HR

Telephone : 01384 370901  
Fax : 01384 880159  
sales@sterlingham.co.uk  
www.sterlingham.co.uk



Handmade  
in the heart of  
BRITAIN

# 4-355-23xx

Glass Rail Single Towel Bar

06 July 2021

44H x 585W x 77D

- |                             |                         |
|-----------------------------|-------------------------|
| UB - UNLACQUERED BRASS      | CP - POLISHED CHROME    |
| BB - BRUSHED BRASS          | NP - POLISHED NICKEL    |
| BN - BRUSHED NICKEL         | LB - LIGHT BRONZE       |
| LAB - LIGHT ANTIQUE BRONZE  | MB - MEDIUM BRONZE      |
| MAB - MEDIUM ANTIQUE BRONZE | DB - DARK BRONZE        |
| DAB - DARK ANTIQUE BRONZE   | GP - GOLD PLATED        |
| AG - ANTIQUE GOLD           | GM - GUN METAL          |
| MWP - MATT WHITE P.COAT     | MBP - MATT BLACK P.COAT |

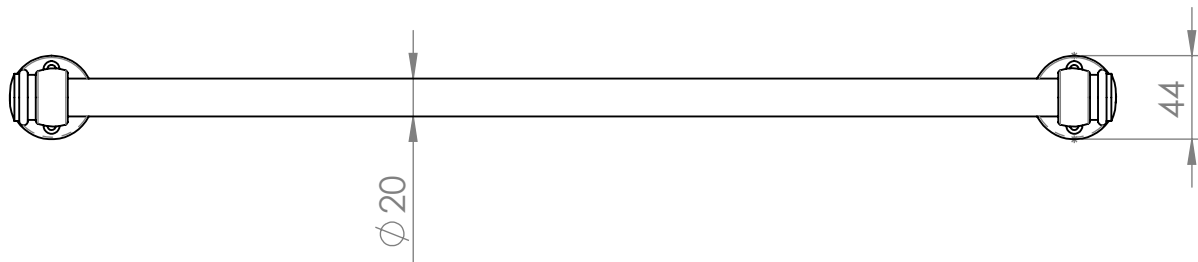
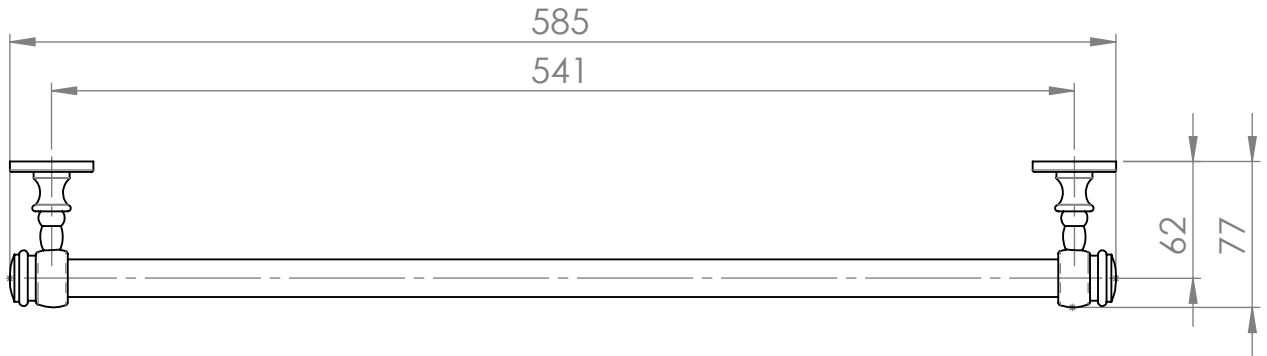
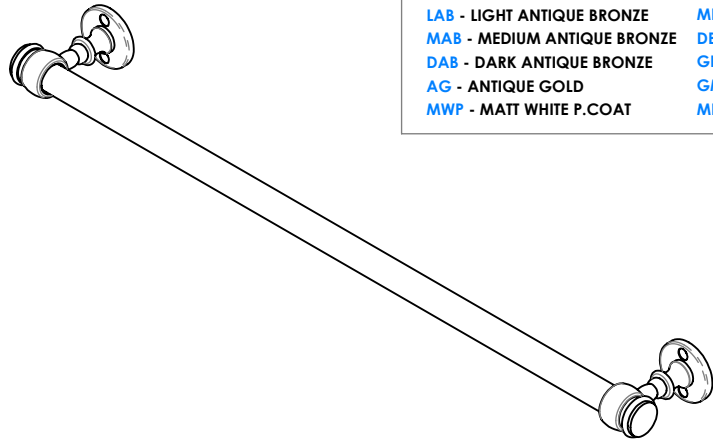

## THE STERLINGHAM CO. LTD.

SCALE: 1:5

APPROX WEIGHT 0.85KG

MANUFACTURED FROM BRASS

Units 2 & 2A Stamford Street  
Amblecote, Stourbridge,  
Worcestershire  
England, DY8 4HR

Telephone : 01384 370901  
Fax : 01384 880159  
sales@sterlingham.co.uk  
www.sterlingham.co.uk



Handmade  
*in the heart of*  
BRITAIN

# 4-355-23CLD-xx

Glass Rail Single Towel Bar

06 July 2021

41H x 585W x 83D

- |                             |                         |
|-----------------------------|-------------------------|
| UB - UNLACQUERED BRASS      | CP - POLISHED CHROME    |
| BB - BRUSHED BRASS          | NP - POLISHED NICKEL    |
| BN - BRUSHED NICKEL         | LB - LIGHT BRONZE       |
| LAB - LIGHT ANTIQUE BRONZE  | MB - MEDIUM BRONZE      |
| MAB - MEDIUM ANTIQUE BRONZE | DB - DARK BRONZE        |
| DAB - DARK ANTIQUE BRONZE   | GP - GOLD PLATED        |
| AG - ANTIQUE GOLD           | GM - GUN METAL          |
| MWP - MATT WHITE P.COAT     | MBP - MATT BLACK P.COAT |

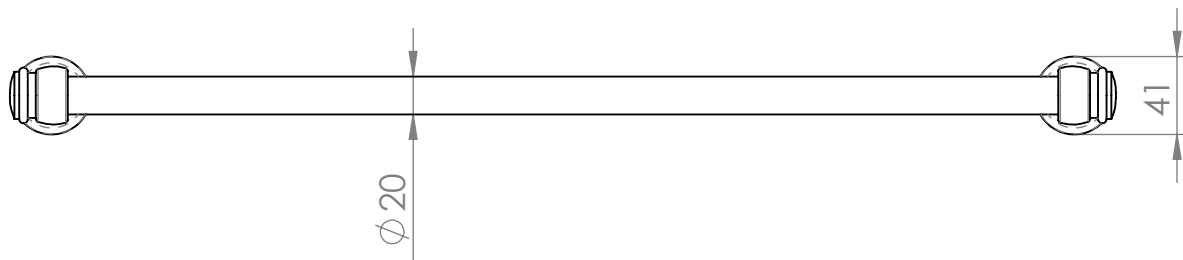
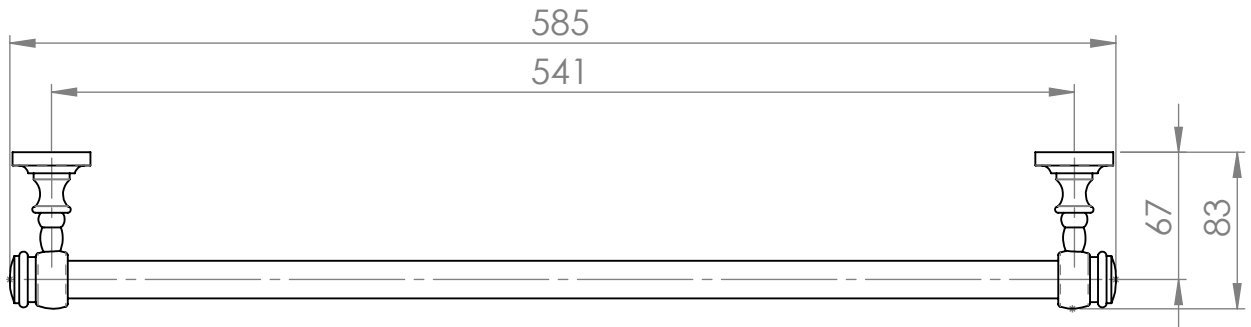
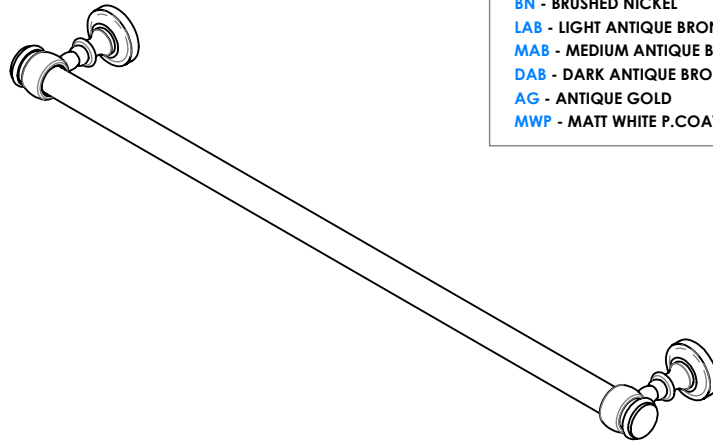

## THE STERLINGHAM CO. LTD.

SCALE: 1:5 | APPROX WEIGHT 0.85KG

MANUFACTURED FROM BRASS

Units 2 & 2A Stamford Street  
Amblecote, Stourbridge,  
Worcestershire  
England, DY8 4HR

Telephone : 01384 370901  
Fax : 01384 880159  
sales@sterlingham.co.uk  
www.sterlingham.co.uk



Handmade  
*in the heart of*  
BRITAIN

**4-355-29xx**

Glass Rail Single Towel Bar

06 July 2021

44H x 738W x 77D

- |                             |                         |
|-----------------------------|-------------------------|
| UB - UNLACQUERED BRASS      | CP - POLISHED CHROME    |
| BB - BRUSHED BRASS          | NP - POLISHED NICKEL    |
| BN - BRUSHED NICKEL         | LB - LIGHT BRONZE       |
| LAB - LIGHT ANTIQUE BRONZE  | MB - MEDIUM BRONZE      |
| MAB - MEDIUM ANTIQUE BRONZE | DB - DARK BRONZE        |
| DAB - DARK ANTIQUE BRONZE   | GP - GOLD PLATED        |
| AG - ANTIQUE GOLD           | GM - GUN METAL          |
| MWP - MATT WHITE P.COAT     | MBP - MATT BLACK P.COAT |

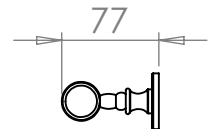
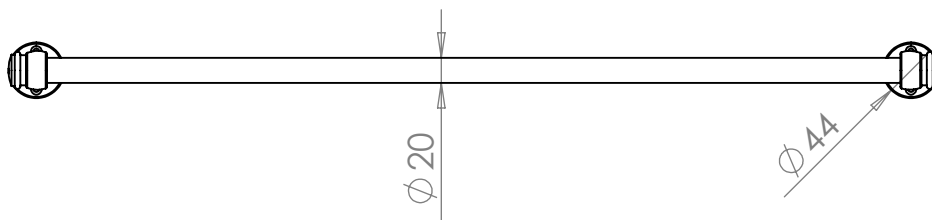
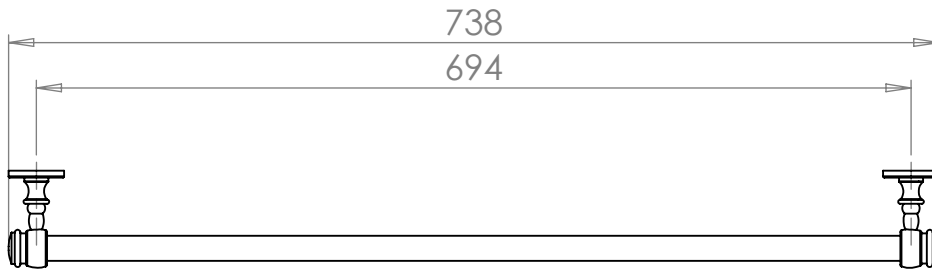
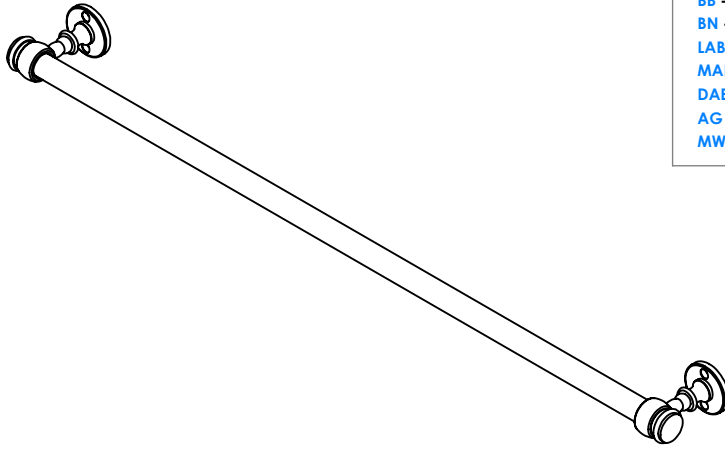

**THE STERLINGHAM** CO. LTD

SCALE: 1:6

APPROX WEIGHT 0.99KG

MANUFACTURED FROM BRASS

Units 2 & 2A Stamford Street  
Amblecote, Stourbridge,  
Worcestershire  
England, DY8 4HR

Telephone : 01384 370901  
Fax : 01384 880159  
sales@sterlingham.co.uk  
www.sterlingham.co.uk



Handmade  
*in the heart of*  
BRITAIN

**4-355-29CLD-xx**

Glass Rail Single Towel Bar

06 July 2021

41H x 738W x 83D

- |                             |                         |
|-----------------------------|-------------------------|
| UB - UNLACQUERED BRASS      | CP - POLISHED CHROME    |
| BB - BRUSHED BRASS          | NP - POLISHED NICKEL    |
| BN - BRUSHED NICKEL         | LB - LIGHT BRONZE       |
| LAB - LIGHT ANTIQUE BRONZE  | MB - MEDIUM BRONZE      |
| MAB - MEDIUM ANTIQUE BRONZE | DB - DARK BRONZE        |
| DAB - DARK ANTIQUE BRONZE   | GP - GOLD PLATED        |
| AG - ANTIQUE GOLD           | GM - GUN METAL          |
| MWP - MATT WHITE P.COAT     | MBP - MATT BLACK P.COAT |

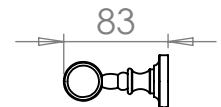
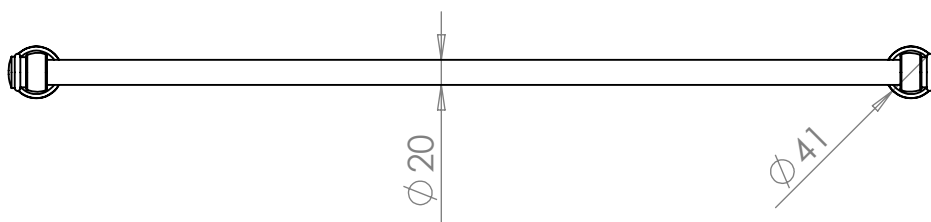
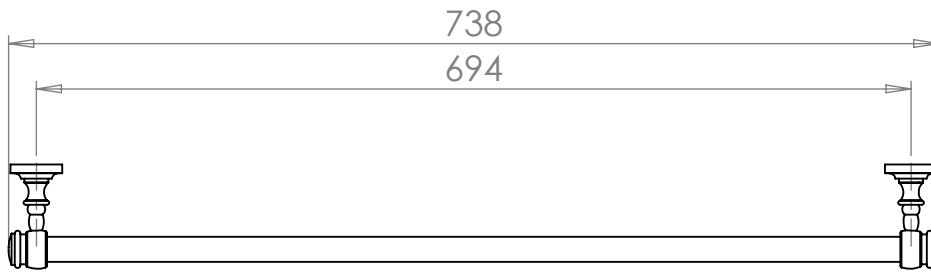
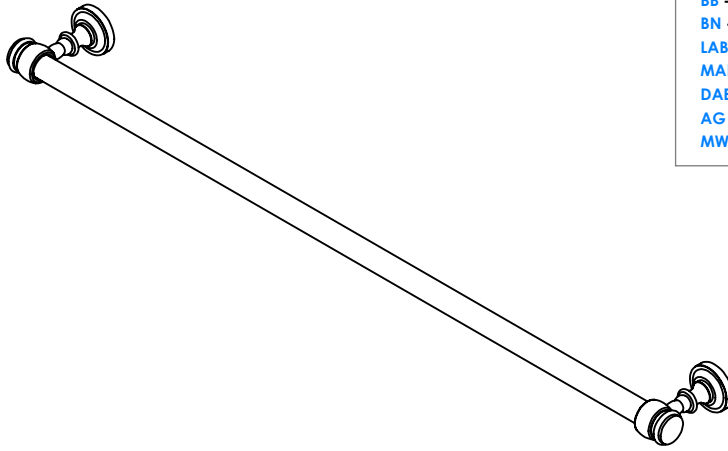

**THE STERLINGHAM** CO. LTD.

SCALE: 1:6

APPROX WEIGHT 0.99KG

MANUFACTURED FROM BRASS

Units 2 & 2A Stamford Street  
Amblecote, Stourbridge,  
Worcestershire  
England, DY8 4HR

Telephone : 01384 370901  
Fax : 01384 880159  
sales@sterlingham.co.uk  
www.sterlingham.co.uk